



Drucktampons - allgemein

Sicotech und **Lang & Schmidt** sind weltweit führende Hersteller von Tampons mit über 1500 verschiedenen Formen. Wenn wir keine geeignete Form haben, werden wir diese für sie fertigen! Gerne arbeiten wir mit Ihnen zusammen und entwickeln einen Tampon für Ihre Bedürfnisse. Wir bieten unsere Tampons mit verschiedenen Trägersystemen an. Meistens wird ein Aluminium- oder Sperrholzsockel verwendet. Neben diesen beiden Möglichkeiten haben wir ein eigenes "Snap-On"-System entwickelt. Diese Option macht es dem Bediener sehr einfach, einen Tampon innerhalb von Sekunden zu wechseln und damit minimale Rüstzeiten zu erreichen. Abhängig von der Stärke und Kontur des zu bedruckenden Produkts muss der Tampon die richtige Shore-Härte- Höhe, Form und Größe aufweisen. Unsere Tampons können in jeder Shore-Härte von 0 bis 30 auf der Shore A Skala hergestellt werden.

Sicotech und **Lang & Schmidt** verfügen über das Wissen und die Erfahrung, um Ihnen bei der Auswahl der optimalen Form und Härte für Ihre Anwendung zu helfen.



Unter idealen Bedingungen können 50.000 - 100.000 Drucke mit einem Tampon gemacht werden. Dies hängt jedoch von mehreren Faktoren ab: - Druckqualität - Farbserie - Die Form, Größe und Härte des Tampons - Die Form des Druckgutes - Die Struktur des Druckgutes (bei scharfen Kanten und Ecken und einer ungünstigen Oberflächenstruktur, kann die Lebensdauer des Drucktampons drastisch verkürzt werden)

Modellübersicht

	Serie 100 Form: rund		Serie 550 Form: rechteckig
	Serie 150 Form: rechteckig		Serie 600 Form: länglich
	Serie 200 Form: rund		Serie 650 Form: länglich
	Serie 250 Form: rund		Serie 700 Form: rechteckig
	Serie 300 Form: rund		Serie 800 Form: länglich
	Serie 350 Form: rechteckig		Serie 850 Form: länglich
	Serie 400 Form: rechteckig		Serie 900 Form: MINI
	Serie 450 Form: quadratisch		Serie 950 Form: SPECIAL
	Serie 500 Form: rechteckig		



SICATECH Tamponhalter

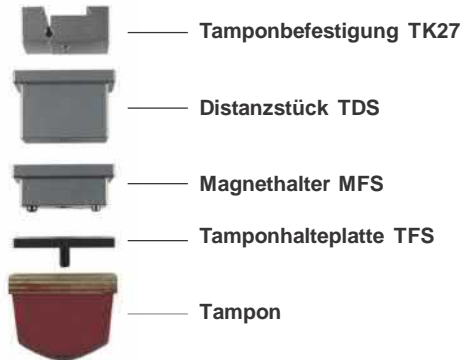

SICATECH Tamponhalter, ist eine magnetische Schnellbefestigung, die es einfach macht, den Tampon positionsgenau zu ersetzen, falls der eingesetzte Tampon defekt ist, oder zum ruhen ausgetauscht wird. Der Tamponhalter kann auch mit Tamponmontagen, die direkt auf unser Klickhalterung gegossen worden sind, kombiniert werden.



Art.-Nr **SICATECH Magnethalter**
200000362 Magnethalter MFS 2, mit 2 Magneten
200000365 Magnethalter MFS 4, mit 4 Magneten



Art.-Nr **SICATECH Tamponhalteplatte**
200000263



Art.-Nr **SICATECH Distanzstücke**
10710102-20 Tampondistans TDS 20, 20 mm
10710102-35 Tampondistans TDS 35, 35 mm
10710102-60 Tampondistans TDS 60, 60 mm

SICATECH Klickhalterung



Zusätzlich zu den Standard-Sockeln und Magnetbefestigungen haben wir noch eine Klickhalterung, bei der der Drucktampon direkt auf die Stahlbasis gegossen wird (kundenspezifisch angepasst). Hier kann der Drucktampon in wenigen Sekunden positionsgenau ohne schrauben und neu einrichten mit minimaler Ausfallzeit einfach ausgetauscht werden.



Beispiele für Tamponmontagen auf Stahlplatten.



Das Klickbefestigungssystem beinhaltet auch eine Spezialverpackung für die Lieferung der Tamponmontage und der Retoure.



Drucktampons - Serie 100

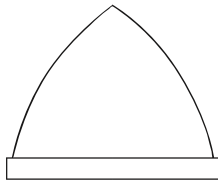

Drucktampons - Serie 100 sind in den Härten 0-30 Shore A standardmäßig auf Holz- Aluminium oder Stahlsockel mit M6 Gewinde erhältlich.

Wir fertigen auch speziell angepasste Klickhalterungen, mit denen Sie den Drucktampon ohne Werkzeug und ohne die Maschine neu einstellen zu müssen, wechseln können.

Für kleinere Druckflächen und Montagen von mehreren kleinen Tampons siehe Serie 900 MINI.

BT106



H
35

Ø 35

Druckbereich*: ca Ø 20

BT336



H
29

35 x 29

Druckbereich*: ca Ø 20
Aluminiumsockel / M6

BT42



H
33

Ø 34

Druckbereich*: ca Ø 20
Aluminiumsockel / M6

BT498



H
45

45 x 45

Druckbereich*: ca Ø 20

HAB101



H
44

Ø 40

Druckbereich*: ca Ø 20

BT110



H
33

Ø 34

Druckbereich*: ca Ø 23
Aluminiumsockel / M6



BT511  Ø 64 Druckbereich*: ca Ø 25	H 55	HAB102  Ø 50 Druckbereich*: ca Ø 25	H 50	T40  Ø 36 Druckbereich*: ca Ø 26	H 32
T07  Ø 64 Druckbereich*: ca Ø 38	H 55	BT388  Ø 57 Druckbereich*: ca Ø 40	H 60	HAB104  Ø 78 Druckbereich*: ca Ø 45	H 64
BT191  Ø 100 Druckbereich*: ca Ø 50	H 89	BT386  Ø 94 Druckbereich*: ca Ø 50	H 80	BT523  Ø 97 Druckbereich*: ca Ø 50	H 77



HAB107  Ø 83 Druckbereich*: ca Ø 50 H 70	BT475  Ø 95 Druckbereich*: ca Ø 55 H 75	BT70  Ø 85 Druckbereich*: ca Ø 55 H 76
BT122  Ø 87 Druckbereich*: ca Ø 57 H 75	BT290  Ø 98 Druckbereich*: ca Ø 60 H 80	HAB105  Ø 98 Druckbereich*: ca Ø 60 H 74
T08  Ø 82 Druckbereich*: ca Ø 60 H 62	BT119  Ø 79 Druckbereich*: ca Ø 63 H 78	BT124  Ø 107 Druckbereich*: ca Ø 65 H 70



Drucktampons - Serie 100

Produktkatalog 2019-1 Seite 4-2 - 4

BT192  Ø 87 Druckbereich*: ca Ø 70 H 75	HAB106  Ø 119 Druckbereich*: ca Ø 70 H 83	BT190  Ø 97 Druckbereich*: ca Ø 80 H 78
BT188  Ø 125 Druckbereich*: ca Ø 100 H 39	 Druckbereich*: ca	 Druckbereich*: ca
 Druckbereich*: ca	 Druckbereich*: ca	 Druckbereich*: ca



Drucktampons - Serie 150

Produktkatalog 2019-1 Sid 4-3 - 1

Drucktampons - Serie 150

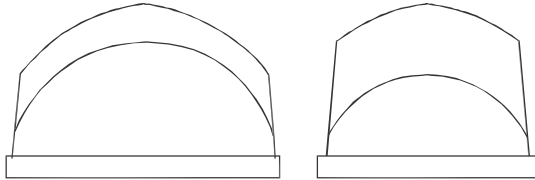

Drucktampons - Serie 150 sind in den Härten 0-30 Shore A standardmäßig auf Holz- Aluminium oder Stahlsockel mit M6 Gewinde erhältlich.

Wir fertigen auch speziell angepasste Klickhalterungen, mit denen Sie den Drucktampon ohne Werkzeug und ohne die Maschine neu einstellen zu müssen, wechseln können.

Für kleinere Druckflächen und Montagen von mehreren kleinen Tampons siehe Serie 900 MINI.

BT219



H
48

73 x 59

Druckbereich*: ca 50 x 40

T26



H
50

79 x 66

Druckbereich*: ca 50 x 40

HAB150



H
80

121 x 74

Druckbereich*: ca 70 x 55

BT124.1



H
70

107 x 80

Druckbereich*: ca 70 x 55

T24/1



H
70

Ø 100

Druckbereich*: ca 75 x 65

BT194



H
94

125 x 80

Druckbereich*: ca 80 x 60



Drucktampons - Serie 150

Produktkatalog 2019-1 Seite 4-3 - 2

BT189		H 80	BT195		H 94	BT261		H 68
120 x 80			125 x 80			123 x 85		
Druckbereich*: ca 80 x 70			Druckbereich*: ca 90 x 55			Druckbereich*: ca 100 x 60		
Druckbereich*: ca			Druckbereich*: ca			Druckbereich*: ca		
Druckbereich*: ca			Druckbereich*: ca			Druckbereich*: ca		



Drucktampons - Serie 200

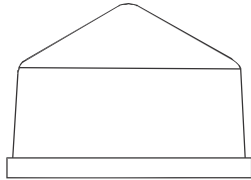

Drucktampons - Serie 200 sind in den Härten 0-30 Shore A standardmäßig auf Holz- Aluminium oder Stahlsockel mit M6 Gewinde erhältlich.

Wir fertigen auch speziell angepasste Klickhalterungen, mit denen Sie den Drucktampon ohne Werkzeug und ohne die Maschine neu einstellen zu müssen, wechseln können.

Für kleinere Druckflächen und Montagen von mehreren kleinen Tampons siehe Serie 900 MINI.

BT105



H
42

Ø 35

Druckbereich*: ca Ø 15

BT35



H
30

Ø 29

Druckbereich*: ca Ø 18
Aluminiumsockel / M6

BT103



H
24

Ø 31

Druckbereich*: ca Ø 20

BT133



H
27

Ø 29

Druckbereich*: ca Ø 20

BT56



H
23

Ø 27

Druckbereich*: ca Ø 20
Aluminiumsockel / M6

T06



H
28

Ø 30

Druckbereich*: ca Ø 21



T03  Ø 35 Drucktampon*: ca Ø 28 H 40	BT436  44 x 44 Drucktampon*: ca Ø 30 H 45	BT492  Ø 40 Drucktampon*: ca Ø 30 H 45
HAB201  Ø 40 Drucktampon*: ca Ø 30 H 34	BT197  Ø 32 Drucktampon*: ca Ø 31 H 44	BT128  Ø 40 Drucktampon*: ca Ø 32 H 41
HAB202  Ø 50 Drucktampon*: ca Ø 35 H 41	T71  Ø 43 Drucktampon*: ca Ø 35 H 41	BT150  Ø 46 Drucktampon*: ca Ø 40 H 40



BT151  Ø 46 Druckbereich*: ca Ø 40	H 39	BT284  Ø 40 Druckbereich*: ca Ø 20 Stalsockel / M6 - C30	H 40	BT389  Ø 62 Druckbereich*: ca Ø 40	H 56
BT390  Ø 47 Druckbereich*: ca Ø 40	H 46	T14  Ø 65 Druckbereich*: ca Ø 40	H 58	BT414  Ø 54 Druckbereich*: ca Ø 42	H 43
HAB203  Ø 60 Druckbereich*: ca Ø 45	H 48	T208  Ø 60 Druckbereich*: ca Ø 45	H 48	BT117  Ø 69 Druckbereich*: ca Ø 50	H 57



BT172  Ø 62 Druckbereich*: ca Ø 50 H 64	BT174  Ø 60 Druckbereich*: ca Ø 50 H 56	BT387  Ø 62 Druckbereich*: ca Ø 50 H 52
BT425  Ø 61 Druckbereich *: ca Ø 50 Aluminiumsockel / M6 H 55	BT489  Ø 40 Druckbereich*: ca Ø 50 H 45	BT503  Ø 65 Druckbereich *: ca Ø 50 Aluminiumsockel / M6 H 54
T09  Ø 61 Druckbereich *: ca Ø 51 H 48	BT160  Ø 65 Druckbereich *: ca Ø 52 H 58	BT416  Ø 61 Druckbereich *: ca Ø 52 Aluminiumsockel / M6 H 51



T44  Ø 65 Druckbereich *: ca Ø 53 H 58	BT109  Ø 65 Druckbereich *: ca Ø 58 H 60	BT385  Ø 62 Druckbereich *: ca Ø 60 H 42
BT476  Ø 77 Druckbereich *: ca Ø 60 H 56	HAB204  Ø 77 Druckbereich *: ca Ø 60 H 51	BT378  Ø 80 Druckbereich *: ca Ø 65 H 78
BT379  Ø 98 Druckbereich *: ca Ø 75 H 90	BT701  Ø 97 Druckbereich *: ca Ø 75 H 60	HAB205  Ø 100 Druckbereich *: ca Ø 75 H 64



BT118  Ø 97 Druckbereich *: ca Ø 78	H 67	T23  Ø 97 Druckbereich *: ca Ø 80	H 62	BT126  Ø 96 Druckbereich *: ca Ø 82	H 92
BT140  Ø 106 Druckbereich *: ca Ø 85	H 93	BT125  Ø 124 Druckbereich *: ca Ø 88	H 98	BT142  Ø 110 Druckbereich *: ca Ø 90	H 93
BT306  Ø 108 Druckbereich *: ca Ø 90	H 75	BT499  144 x 120 Druckbereich *: ca Ø 90	H 96	BT196  Ø 115 Druckbereich *: ca Ø 95	H 93



BT141



H 90

Ø 110

Druckbereich *: ca Ø 100

BT145



H 110

Ø 139

Druckbereich *: ca Ø 100

HAB207



H 88

Ø 136

Druckbereich *: ca Ø 105

BT536



H 145

Ø 210

Druckbereich *: ca Ø 160

Druckbereich *: ca

Druckbereich *: ca

Druckbereich *: ca

Druckbereich *: ca

Druckbereich *: ca



Drucktampons - Serie 250

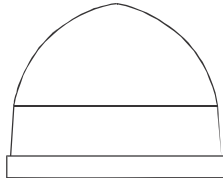

Drucktampons - Serie 250 sind in den Härten 0-30 Shore A standardmäßig auf Holz- Aluminium oder Stahlsockel mit M6 Gewinde erhältlich.

Wir fertigen auch speziell angepasste Klickhalterungen, mit denen Sie den Drucktampon ohne Werkzeug und ohne die Maschine neu einstellen zu müssen, wechseln können.

Für kleinere Druckflächen und Montagen von mehreren kleinen Tampons siehe Serie 900 MINI.

BT90



H
58

Ø 50

Druckbereich *: ca Ø 36

BT114



H
60

Ø 60

Druckbereich *: ca Ø 40

BT115



H
48

Ø 64

Druckbereich *: ca Ø 40

BT355



H
59

Ø 63

Druckbereich *: ca Ø 40

BT116



H
57

Ø 69

Druckbereich *: ca Ø 55

BT380



H
70

Ø 98

Druckbereich *: ca Ø 60



Drucktampons - Serie 250

Produktkatalog 2019-1 Seite 4-5 - 2

BT454  Ø 100 Druckbereich *: ca Ø 65	H 92	BT193  Ø 97 Druckbereich *: ca Ø 75	H 78	BT120  Ø 114 Druckbereich *: ca Ø 78	H 74
BT121  Ø 98 Druckbereich *: ca Ø 78	H 60	BT360  Ø 114 Druckbereich *: ca Ø 80	H 74	T24  Ø 108 Druckbereich *: ca Ø 80	H 68
BT61  Ø 110 Druckbereich *: ca Ø 90	H 88				



Drucktampons - Serie 300

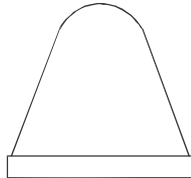

Drucktampons – Serie 300 sind in den Härten 0-30 Shore A standartmäßig auf Holz- Aluminium oder Stahlsockel mit M6 Gewinde erhältlich.

Wir fertigen auch speziell angepasste Klickhalterungen, mit denen Sie den Drucktampon ohne Werkzeug und ohne die Maschine neu einstellen zu müssen, wechseln können.

Für kleinere Druckflächen und Montagen von mehreren kleinen Tampons siehe Serie 900 MINI.

HAB304



H
36

Ø 34

Druckbereich *: ca Ø 20
Aluminiumsockel

T83



H
32

Ø 30

Druckbereich *: ca Ø 23

BT166



H
57

Ø 50

Druckbereich *: ca Ø 30

HAB301



H
48

Ø 54

Druckbereich *: ca Ø 30

BT74



H
88

Ø 86

Druckbereich *: ca Ø 40

T66



H
53

Ø 63

Druckbereich *: ca Ø 40



Drucktampons - Serie 300

Produktkatalog 2019-1 Seite 4-6 - 2

BT75  Ø 86 Druckbereich *: ca Ø 45 H 85	BT71  Ø 98 Druckbereich *: ca Ø 55 H 80	T16  Ø 80 Druckbereich *: ca Ø 60 H 70
 Druckbereich *: ca	 Druckbereich *: ca	 Druckbereich *: ca
 Druckbereich *: ca	 Druckbereich *: ca	 Druckbereich *: ca



Drucktampons - Serie 350

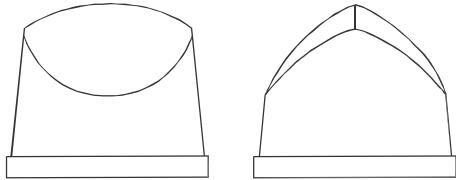

Drucktampons – Serie 350 sind in den Härten 0-30 Shore A standardmäßig auf Holz- Aluminium oder Stahlsockel mit M6 Gewinde erhältlich.

Wir fertigen auch speziell angepasste Klickhalterungen, mit denen Sie den Drucktampon ohne Werkzeug und ohne die Maschine neu einstellen zu müssen, wechseln können.

Für kleinere Druckflächen und Montagen von mehreren kleinen Tampons siehe Serie 900 MINI.

BT111



H
49

Ø 60

Druckbereich *: ca 30 x 22

BT66



H
60

Ø 70

Druckbereich *: ca 38 x 32

T28



H
62

Ø 64

Druckbereich *: ca 40 x 25

BT152



H
50

Ø 58

Druckbereich *: ca 45 x 28

BT108



H
70

Ø 70

Druckbereich *: ca 45 x 30

BT68



H
50

Ø 70

Druckbereich *: ca 50 x 35



Drucktampons - Serie 350

Produktkatalog 2019-1 Seite 4-7 - 2

BT123  Ø 82 Druckbereich *: ca 55 x 40	 H 67 Druckbereich *: ca 10	 Druckbereich *: ca
 Druckbereich *: ca	 Druckbereich *: ca	 Druckbereich *: ca
 Druckbereich *: ca	 Druckbereich *: ca	 Druckbereich *: ca



Drucktampons - Serie 400

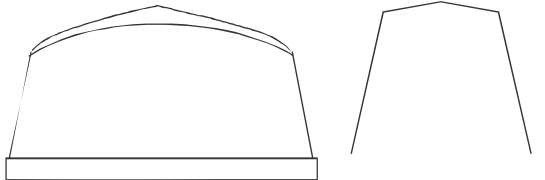

Drucktampons – Serie 400 sind in den Härten 0-30 Shore A standardmäßig auf Holz- Aluminium oder Stahlsockel mit M6 Gewinde erhältlich.

Wir fertigen auch speziell angepasste Klickhalterungen, mit denen Sie den Drucktampon ohne Werkzeug und ohne die Maschine neu einstellen zu müssen, wechseln können.

Für kleinere Druckflächen und Montagen von mehreren kleinen Tampons siehe Serie 900 MINI.

BT433



H 30

38 x 25

Druckbereich *: ca 25 x 20

BT495



H 30

35 x 25

Druckbereich *: ca 25 x 20

BT177



H 40

42 x 34

Druckbereich *: ca 27 x 20

BT470



H 35

43 x 24

Druckbereich *: ca 30 x 16

BT432



H 30

35 x 24

Druckbereich *: ca 30 x 18

BT494



H 30

35 x 25

Druckbereich *: ca 30 x 18



Drucktampons - Serie 400

Produktkatalog 2019-1 Seite 4-8 - 2

HAB419 <input type="checkbox"/>	 H 37 46 x 34 Druckbereich * ca 30 x 22	BT210 <input type="checkbox"/>	 H 42 Ø 45 Druckbereich *: ca 32 x 24	BT231 <input type="checkbox"/>	 H 45 55 x 26 Druckbereich *: ca 34 x 15
HAB402 <input type="checkbox"/>	 H 38 44 x 35 Druckbereich *: ca 34 x 25	T90/1 <input type="checkbox"/>	 H 45 55 x 25 Druckbereich *: ca 35 x 16	BT43 <input type="checkbox"/>	 H 43 Ø 47 Druckbereich *: ca 38 x 20
T20 <input type="checkbox"/>	 H 33 54 x 37 Druckbereich *: ca 40 x 20	T20/1 <input type="checkbox"/>	 H 33 54 x 37 Druckbereich *: ca 40 x 26	BT348 <input type="checkbox"/>	 H 35 54 x 29 Druckbereich *: ca 40 x 29









BT514  72 x 64 Druckbereich *: ca 40 x 40 H 66	T90  55 x 25 Druckbereich *: ca 42 x 16 H 45	BT277  82 x 45 Druckbereich *: ca 42 x 30 Stalsocket / M6 - C60 H 44
BT21  52 x 25 Druckbereich *: ca 44 x 15 H 46	BT525  59 x 39 Druckbereich *: ca 45 x 25 H 49	BT491  59 x 34 Druckbereich *: ca 45 x 25 H 50
BT203  56 x 38 Druckbereich *: ca 45 x 27 H 33	HAB410  60 x 40 Druckbereich *: ca 45 x 28 H 42	T70  56 x 33 Druckbereich *: ca 45 x 28 H 47



Drucktampons - Serie 400









Produktkatalog 2019-1 Seite 4-8 - 4

BT164	 H 47	HAB403	 H 48	BT233	 H 48
59 x 36		60 x 45		55 x 44	
Druckbereich *: ca 45 x 32		Druckbereich *: ca 45 x 32		Druckbereich *: ca 48 x 35	
T113	 H 60	BT288	 H 50	T68	 H 52
66 x 63		64 x 35		79 x 35	
Druckbereich *: ca 48 x 44		Druckbereich *: ca 50 x 24		Druckbereich *: ca 50 x 24	
BT488	 H 50	BT215	 H 55	T36	 H 57
65 x 32		60 x 42		64 x 48	
Druckbereich *: ca 50 x 25		Druckbereich *: ca 50 x 30		Druckbereich *: ca 50 x 35	



Drucktampons - Serie 400

Produktkatalog 2019-1 Seite 4-8 - 5

BT170 <input type="checkbox"/>	 H 48	T76 <input type="checkbox"/>	 H 56	BT469 <input type="checkbox"/>	 H 44
61 x 28		74 x 45		65 x 35	
Druckbereich *: ca 52 x 20		Druckbereich *: ca 54 x 26		Druckbereich *: ca 55 x 20	
T110 <input type="checkbox"/>	 H 60	BT217 <input type="checkbox"/>	 H 53	T50 <input type="checkbox"/>	 H 47
79 x 49		68 x 59		73 x 59	
Druckbereich *: ca 58 x 30		Druckbereich *: ca 56 x 40		Druckbereich *: ca 58 x 40	
T50/1 <input type="checkbox"/>	 H 47	BT337 <input type="checkbox"/>	 H 53	HAB407 <input type="checkbox"/>	 H 40
73 x 59		85 x 34		78 x 38	
Druckbereich *: ca 58 x 40		Druckbereich *: ca 60 x 25		Druckbereich *: ca 60 x 28	



Drucktampons - Serie 400









Produktkatalog 2019-1 Seite 4-8 - 6

BT485	 <p>H 56</p>	BT534	 <p>H 66</p>	HAB404	 <p>H 58</p>
81 x 53		84 x 55		74 x 54	
Druckbereich *: ca 60 x 30		Druckbereich *: 60 x 30		Druckbereich *: ca 60 x 40	
BT214	 <p>H 52</p>	BT216	 <p>H 46</p>	T106	 <p>H 60</p>
86 x 35		79 x 51		82 x 56	
Druckbereich *: ca 65 x 22		Druckbereich *: ca 65 x 34		Druckbereich *: ca 65 x 34	
T49	 <p>H 51</p>	T411	 <p>H 78</p>	T412	 <p>H 62</p>
82 x 60		100 x 75		94 x 75	
Druckbereich *: ca 65 x 40 Aluminiumsockel / M6		Druckbereich *: ca 65 x 55		Druckbereich *: ca 65 x 55	



T60/1 <input type="checkbox"/>	 H 47	BT223 <input type="checkbox"/>	 H 48	T80 <input type="checkbox"/>	 H 56
90 x 55 Druckbereich *: ca 68 x 20		88 x 58 Druckbereich *: ca 70 x 20		83 x 37 Druckbereich *: ca 70 x 26	
T110/1 <input type="checkbox"/>	 H 56	HAB409 <input type="checkbox"/>	 H 65	HAB405 <input type="checkbox"/>	 H 68
83 x 50 Druckbereich *: ca 70 x 38		85 x 52 Druckbereich *: ca 70 x 40		92 x 66 Druckbereich *: ca 70 x 45	
BT400 <input type="checkbox"/>	 H 68	BT401 <input type="checkbox"/>	 H 60	BT276 <input type="checkbox"/>	 H 66
105 x 70 Druckbereich *: ca 70 x 50		105 x 70 Druckbereich *: 70 x 50		104 x 69 Druckbereich *: ca 70 x 55	







T98.1	 <p>H 65</p> <p>84 x 72</p> <p>Druckbereich *: ca 70 x 60</p>	BT253	 <p>H 56</p> <p>95 x 57</p> <p>Druckbereich *: ca 72 x 39</p>	T111/1	 <p>H 56</p> <p>88 x 63</p> <p>Druckbereich *: ca 72 x 48</p>
T110/2	 <p>H 56</p> <p>83 x 50</p> <p>Druckbereich *: ca 74 x 39</p>	BT371	 <p>H 69</p> <p>99 x 76</p> <p>Druckbereich *: ca 75 x 60</p>	T98	 <p>H 65</p> <p>84 x 72</p> <p>Druckbereich *: ca 75 x 62</p>
T130	 <p>H 57</p> <p>93 x 47</p> <p>Druckbereich *: ca 80 x 32 (special)</p>	BT372	 <p>H 70</p> <p>97 x 90</p> <p>Druckbereich *: ca 80 x 70</p>	T121	 <p>H 63</p> <p>100 x 70</p> <p>Druckbereich *: ca 83 x 58</p>



Drucktampons - Serie 400



Produktkatalog 2019-1 Seite 4-8 - 9

T128 <input type="checkbox"/>	 <p>H 56</p>	T111/2 <input type="checkbox"/>	 <p>H 62</p>	HAB408 <input type="checkbox"/>	 <p>H 58</p>
96 x 38		96 x 60		100 x 50	
Druckbereich *: ca 84 x 21		Druckbereich *: ca 84 x 48		Druckbereich *: ca 85 x 38	
T406 <input type="checkbox"/>	 <p>H 75</p>	BT255 <input type="checkbox"/>	 <p>H 63</p>	T84 <input type="checkbox"/>	 <p>H 65</p>
110 x 77		103 x 73		105 x 77	
Druckbereich *: ca 85 x 56		Druckbereich *: ca 85 x 58		Druckbereich *: ca 85 x 58	
BT270 <input type="checkbox"/>	 <p>H 80</p>	BT89 <input type="checkbox"/>	 <p>H 56</p>	T123 <input type="checkbox"/>	 <p>H 72</p>
140 x 104		100 x 66		98 x 89	
Druckbereich *: ca 85 x 75		Druckbereich *: 86 x 54		Druckbereich *: ca 87 x 75	



Drucktampons - Serie 400

Produktkatalog 2019-1 Seite 4-8 - 10

T29	 <p>H 62</p>	BT479	 <p>H 55</p>	BT267	 <p>H 90</p>
130 x 60		126 x 66		145 x 75	
Druckbereich *: ca 100 x 35		Druckbereich *: ca 100 x 38		Druckbereich *: ca 100 x 40	
T38	 <p>H 68</p>	T61	 <p>H 65</p>	BT338	 <p>H 62</p>
115 x 85		131 x 61		136 x 44	
Druckbereich *: ca 100 x 66		Druckbereich *: ca 105 x 55		Druckbereich *: ca 110 x 35	
BT302	 <p>H 72</p>	T31	 <p>H 60</p>	T35	 <p>H 66</p>
131 x 84		132 x 46		138 x 100	
Druckbereich *: ca 110 x 57		Druckbereich *: ca 115 x 30		Druckbereich *: ca 115 x 75	



BT186



H 100

160 x 125

Druckbereich *: ca 115 x 80

T99



H 88

159 x 128

Druckbereich *: ca 125 x 98

BT339



H 120

194 x 108

Druckbereich *: ca 150 x 78

HAB417



H 70

200 x 110

Druckbereich *: ca 150 x 85

BT285



H 87

179 x 134

Druckbereich *: ca 150 x 110

BT528



H 130

170 x 140

Druckbereich *: ca 155 x 125

BT376



H 78

198 x 45

Druckbereich *: ca 165 x 34

T97



H 98

195 x 98

Druckbereich *: ca 165 x 38

T201



H 106

193 x 96

Druckbereich *: ca 175 x 68



Drucktampons - Serie 400

Produktkatalog 2019-1 Seite 4-8 - 12

BT187	 <p>H 125</p>	T96	 <p>H 130</p>	
228 x 129		282 x 102		
Druckbereich *: ca 180 x 85		Druckbereich *: ca 240 x 55		Druckbereich *: ca
Druckbereich *: ca		Druckbereich *: ca		Druckbereich *: ca
Druckbereich *: ca		Druckbereich *: ca		Druckbereich *: ca



Drucktampons - Serie 450

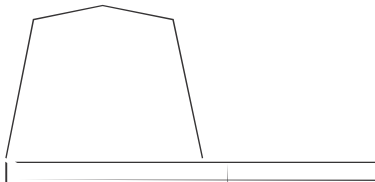

Drucktampons – Serie 450 sind in den Härten 0-30 Shore A standardmäßig auf Holz- Aluminium oder Stahlsockel mit M6 Gewinde erhältlich.

Wir fertigen auch speziell angepasste Klickhalterungen, mit denen Sie den Drucktampon ohne Werkzeug und ohne die Maschine neu einstellen zu müssen, wechseln können.

Für kleinere Druckflächen und Montagen von mehreren kleinen Tampons siehe Serie 900 MINI.

T33



H 36

34 x 34

Druckbereich *: ca 26 x 26

BT281



H 50

43 x 43

Druckbereich *: ca 36 x 36

BT434



H 50

44 x 44

Druckbereich *: ca 36 x 36

BT208



H 42

47 x 47

Druckbereich *: ca 38 x 38

T89



H 43

50 x 50

Druckbereich *: ca 38 x 38

T126



H 60



64 x 64

Druckbereich *: ca 40 x 40



Drucktampons - Serie 450

Produktkatalog 2019-1 Seite 4-9 - 2

BT165 <input type="checkbox"/>	 H 65	BT535 <input type="checkbox"/>	 H 56	BT146 <input type="checkbox"/>	 H 64
78 x 78		70 x 65		70 x 70	
Druckbereich *: ca 50 x 50		Druckbereich *: ca 50 x 50		Druckbereich *: ca 56 x 56	
BT67 <input type="checkbox"/>	 H 50	T52 <input type="checkbox"/>	 H 66	T19 <input type="checkbox"/>	 H 66
77 x 77		78 x 78		94 x 94	
Druckbereich *: ca 56 x 56		Druckbereich *: ca 60 x 60		Druckbereich *: ca 68 x 68	
BT418 <input type="checkbox"/>	 H 98	BT167 <input type="checkbox"/>	 H 108	BT168 <input type="checkbox"/>	 H 100
109 x 114		142 x 142		140 x 140	
Druckbereich *: ca 100 x 100		Druckbereich *: ca 105 x 105		Druckbereich *: ca 120 x 120	



BT426 <input type="checkbox"/>	<input type="checkbox"/>	<input type="checkbox"/>
 <p>H 100</p>		
139 x 139		
Druckbereich *: ca 120 x 120	Druckbereich *: ca	Druckbereich *: ca
<input type="checkbox"/>	<input type="checkbox"/>	<input type="checkbox"/>
Druckbereich *: ca	Druckbereich *: ca	Druckbereich *: ca
<input type="checkbox"/>	<input type="checkbox"/>	<input type="checkbox"/>
Druckbereich *: ca	Druckbereich *: ca	Druckbereich *: ca



Drucktampons - Serie 500

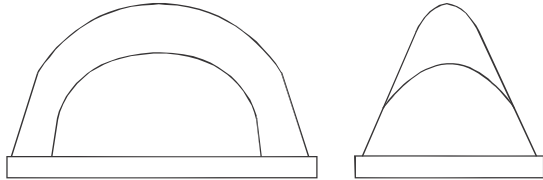

Drucktampons – Serie 500 sind in den Härten 0-30 Shore A standardmäßig auf Holz- Aluminium oder Stahlsockel mit M6 Gewinde erhältlich.

Wir fertigen auch speziell angepasste Klickhalterungen, mit denen Sie den Drucktampon ohne Werkzeug und ohne die Maschine neu einstellen zu müssen, wechseln können.

Für kleinere Druckflächen und Montagen von mehreren kleinen Tampons siehe Serie 900 MINI.

T04



H 35

57 x 34

Druckbereich *: ca 34 x 19

HAB501



H 40

54 x 35

Druckbereich *: ca 35 x 15

HAB511



H 39

57 x 31

Druckbereich *: ca 35 x 15

BT512



H 49

93 x 48

Druckbereich *: ca 40 x 15

HAB512



H 50

80 x 35

Druckbereich *: ca 45 x 18

T78



H 44

75 x 48

Druckbereich *: ca 45 x 18



Drucktampons - Serie 500

Produktkatalog 2019-1 Sid 4-10 - 2

BT403 <input type="checkbox"/>	 H 52 87 x 50 Druckbereich *: ca 50 x 15	BT332 <input type="checkbox"/>	 H 52 79 x 31 Druckbereich *: ca 50 x 18	T502 <input type="checkbox"/>	 H 50 81 x 50 Druckbereich *: ca 50 x 20
HAB513 <input type="checkbox"/>	 H 54 98 x 40 Druckbereich *: ca 55 x 22	BT515 <input type="checkbox"/>	 H 50 84 x 52 Druckbereich *: ca 60 x 15	BT320 <input type="checkbox"/>	 H 52 99 x 53 Druckbereich *: ca 60 x 18
BT220 <input type="checkbox"/>	 H 48 97 x 53 Druckbereich *: ca 60 x 22	HAB503 <input type="checkbox"/>	 H 55 97 x 54 Druckbereich *: ca 60 x 25	T91 <input type="checkbox"/>	 H 55 92 x 58 Druckbereich *: ca 60 x 32



BT287	<input type="checkbox"/>
	H 45
128 x 54	
Druckbereich *: ca 65 x 18	

T93	<input type="checkbox"/>
	H 51
100 x 52	
Druckbereich *: ca 65 x 20	

BT93	<input type="checkbox"/>
	H 53
110 x 55	
Druckbereich *: ca 70 x 23	

BT225	<input type="checkbox"/>
	H 58
125 x 70	
Druckbereich *: ca 70 x 25	

HAB504	<input type="checkbox"/>
	H 66
138 x 64	
Druckbereich *: ca 80 x 28	

BT265	<input type="checkbox"/>
	H 77
160 x 81	
Druckbereich *: ca 90 x 20	

BT395	<input type="checkbox"/>
	H 59
147 x 53	
Druckbereich *: ca 90 x 25	

BT474	<input type="checkbox"/>
	H 55
145 x 73	
Druckbereich *: ca 90 x 30	

BT266	<input type="checkbox"/>
	H 59
200 x 63	
Druckbereich *: ca 120 x 25	



Drucktampons - Serie 550

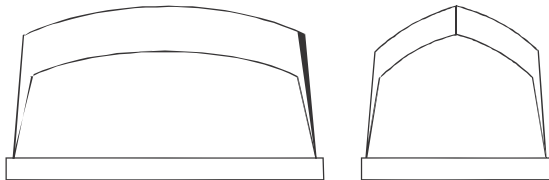

Drucktampons – Serie 550 sind in den Härten 0-30 Shore A standardmäßig auf Holz- Aluminium oder Stahlsockel mit M6 Gewinde erhältlich.

Wir fertigen auch speziell angepasste Klickhalterungen, mit denen Sie den Drucktampon ohne Werkzeug und ohne die Maschine neu einstellen zu müssen, wechseln können.

Für kleinere Druckflächen und Montagen von mehreren kleinen Tampons siehe Serie 900 MINI.

T112



H
48

66 x 41

Druckbereich *: ca 40 x 9
Aluminiumsockel / M6

HAB512.3



H
47

49 x 35

Druckbereich *: ca 40 x 18
Aluminiumsockel / M6

T112/1



H
48

66 x 41

Druckbereich *: ca 42 x 9
Aluminiumsockel / M6

BT176



H
47

60 x 36

Druckbereich *: ca 45 x 20

BT374



H
32

60 x 28

Druckbereich *: ca 50 x 15

BT112



H
50

80 x 46

Druckbereich *: ca 55 x 35



Drucktampons - Serie 550



Produktkatalog 2019-1 Seite 4-11 - 2

BT129	 <p>H 64</p> <p>Ø 87</p> <p>Druckbereich *: ca 55 x 35</p>	BT222	 <p>H 48</p> <p>73 x 56</p> <p>Druckbereich *: ca 55 x 40</p>	BT471	 <p>H 48</p> <p>76 x 47</p> <p>Druckbereich *: ca 60 x 30</p>
BT435	 <p>H 48</p> <p>78 x 50</p> <p>Druckbereich *: ca 60 x 35</p>	BT367	 <p>H 45</p> <p>90 x 49</p> <p>Druckbereich *: ca 70 x 22</p>	BT466	 <p>H 50</p> <p>87 x 53</p> <p>Druckbereich *: ca 70 x 25</p>
BT328	 <p>H 55</p> <p>94 x 52</p> <p>Druckbereich *: ca 70 x 35</p>	BT477	 <p>H 48</p> <p>92 x 48</p> <p>Druckbereich *: ca 70 x 38</p>	BT419	 <p>H 60</p> <p>92 x 51</p> <p>Druckbereich *: ca 75 x 30 Stalsocket / M6 - C36</p>



BT420 <input type="checkbox"/>	 <p>H 45</p> <p>92 x 51</p> <p>Druckbereich *: ca 75 x 30 Stalsocket / M6 - C36</p>	BT271 <input type="checkbox"/>	 <p>H 68</p> <p>101 x 79</p> <p>Druckbereich *: ca 80 x 45</p>	BT286 <input type="checkbox"/>	 <p>H 60</p> <p>150 x 70</p> <p>Druckbereich *: ca 90 x 32</p>
BT243 <input type="checkbox"/>	 <p>H 70</p> <p>138 x 78</p> <p>Druckbereich *: ca 100 x 42</p>	BT383 <input type="checkbox"/>	 <p>H 64</p> <p>132 x 90</p> <p>Druckbereich *: ca 115 x 70</p>	BT264 <input type="checkbox"/>	 <p>H 70</p> <p>185 x 78</p> <p>Druckbereich *: ca 145 x 42</p>
BT541 <input type="checkbox"/>	 <p>H 64</p> <p>164 x 88</p> <p>Druckbereich *: ca 145 x 70</p>	BT41 <input type="checkbox"/>	 <p>H 110</p> <p>232 x 150</p> <p>Druckbereich *: ca 180 x 110</p>	BT413 <input type="checkbox"/>	 <p>H 61</p> <p>258 x 60</p> <p>Druckbereich *: ca 200 x 35</p>



<p>T169</p>  <p>H 60</p> <p>265 x 60</p> <p>Druckbereich *: ca 210 x 30</p>	<p>BT542</p>  <p>H 60</p> <p>342 x 88</p> <p>Druckbereich *: ca 300 x 70 Stalsocket / M6 - C126</p>	<p>Druckbereich *: ca</p>
<p>Druckbereich *: ca</p>	<p>Druckbereich *: ca</p>	<p>Druckbereich *: ca</p>
<p>Druckbereich *: ca</p>	<p>Druckbereich *: ca</p>	<p>Druckbereich *: ca</p>



Drucktampons - Serie 600

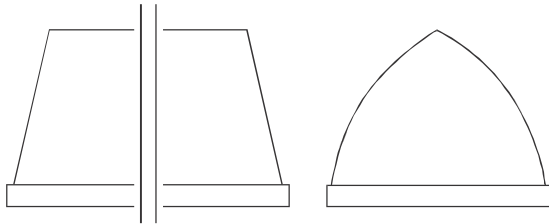

Drucktampons – Serie 600 sind in den Härten 0-30 Shore A standardmäßig auf Holz- Aluminium oder Stahlsockel mit M6 Gewinde erhältlich.

Wir fertigen auch speziell angepasste Klickhalterungen, mit denen Sie den Drucktampon ohne Werkzeug und ohne die Maschine neu einstellen zu müssen, wechseln können.

Für kleinere Druckflächen und Montagen von mehreren kleinen Tampons siehe Serie 900 MINI.

T01/1



H
39

39 x 35

Druckbereich *: ca 20 x 20
Aluminiumsockel / M6

BT463



H
37

27 x 35

Druckbereich *: ca 25 x 15

T01



H
39

65 x 35

Druckbereich *: ca 50 x 20

BT464



H
37

100 x 35

Druckbereich *: ca 55 x 15

BT209



H
37

84 x 35

Druckbereich *: ca 68 x 12

BT465



H
37

100 x 35

Druckbereich *: ca 72 x 15



Drucktampons - Serie 600

Produktkatalog 2019-1 Seite 4-12 - 2

BT242	HAB612	HAB610
 <p>H 33</p>	 <p>H 48</p>	 <p>H 35</p>
140 x 30	289 x 85	304 x 40
Druckbereich *: ca 135 x 15	Druckbereich *: ca 255 x 36	Druckbereich *: ca 275 x 18
HAB611		
 <p>H 65</p>		
405 x 88		
Druckbereich *: ca 360 x 40	Druckbereich *: ca	Druckbereich *: ca
Druckbereich *: ca	Druckbereich *: ca	Druckbereich *: ca



Drucktampons - Serie 650

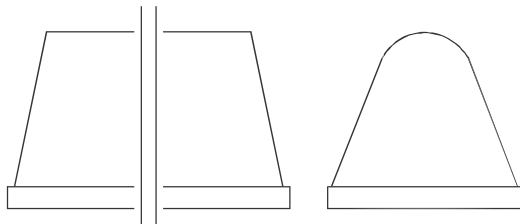

Drucktampons – Serie 650 sind in den Härten 0-30 Shore A standardmäßig auf Holz- Aluminium oder Stahlsockel mit M6 Gewinde erhältlich.

Wir fertigen auch speziell angepasste Klickhalterungen, mit denen Sie den Drucktampon ohne Werkzeug und ohne die Maschine neu einstellen zu müssen, wechseln können.

Für kleinere Druckflächen und Montagen von mehreren kleinen Tampons siehe Serie 900 MINI.

T211/1



H
30

47 x 31

Druckbereich *: ca 20 x 8

BT211



H
29

46 x 32

Druckbereich *: ca 35 x 12
Aluminiumsockel / M6

BT258



H
27

49 x 26

Druckbereich *: ca 42 x 10

HAB650



H
40

96 x 50

Druckbereich *: ca 60 x 20

BT199



H
58

111 x 65

Druckbereich *: ca 65 x 30

BT555



H
33

92 x 30

Druckbereich *: ca 75 x 12



BT137  H 40 137 x 50 Druckbereich *: ca 130 x 20	T69  H 58 204 x 65 Druckbereich *: ca 135 x 25	HAB651  H 40 184 x 50 Druckbereich *: ca 150 x 20
HAB652  H 40 245 x 50 Druckbereich *: ca 210 x 20	BT213  H 26 226 x 26 Druckbereich *: ca 215 x 10	BT297  H 70 245 x 68 Druckbereich *: ca 230 x 15
BT59  H 29 284 x 28 Druckbereich *: ca 270 x 18	HAB653  H 40 424 x 50 Druckbereich *: ca 390 x 20	 Druckbereich *: ca



Drucktampons - Serie 700

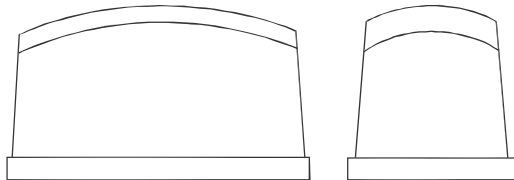

Drucktampons – Serie 700 sind in den Härten 0-30 Shore A standardmäßig auf Holz- Aluminium oder Stahlsockel mit M6 Gewinde erhältlich.

Wir fertigen auch speziell angepasste Klickhalterungen, mit denen Sie den Drucktampon ohne Werkzeug und ohne die Maschine neu einstellen zu müssen, wechseln können.

Für kleinere Druckflächen und Montagen von mehreren kleinen Tampons siehe Serie 900 MINI.

T77



H
34

44 x 30

Druckbereich *: ca 33 x 18

T11



H
39

46 x 28

Druckbereich *: ca 34 x 16

BT153



H
29

52 x 12

Druckbereich *: ca 40 x 14
Aluminiumsockel / M5 (M4 x 2)

BT362



H
24

47 x 16

Druckbereich *: ca 40 x 14
Aluminiumsockel / M5

BT530



H
36

49 x 44

Druckbereich *: ca 42 x 36
Stålsockel / M6 - C32

BT496



H
48

65 x 30

Druckbereich *: ca 45 x 22







Drucktampons - Serie 700

Produktkatalog 2019-1 Seite 4-14 - 2

BT493 <input type="checkbox"/>	 H 46 65 x 30 Druckbereich *: ca 50 x 18	BT315 <input type="checkbox"/>	 H 78 88 x 64 Druckbereich *: ca 55 x 48	BT221 <input type="checkbox"/>	 H 48 78 x 52 Druckbereich *: ca 60 x 32
BT473 <input type="checkbox"/>	 H 50 80 x 33 Druckbereich *: ca 65 x 25	BT478 <input type="checkbox"/>	 H 49 80 x 34 Druckbereich *: ca 65 x 25	BT226 <input type="checkbox"/>	 H 52 94 x 43 Druckbereich *: ca 74 x 28
BT544 <input type="checkbox"/>	 H 58 87 x 46 Druckbereich *: ca 74 x 35	BT397 <input type="checkbox"/>	 H 67 100 x 90 Druckbereich *: ca 78 x 78	BT250 <input type="checkbox"/>	 H 53 99 x 35 Druckbereich *: ca 80 x 22



BT218 <input type="checkbox"/>	 H 52 95 x 44 Druckbereich *: ca 80 x 30	BT487 <input type="checkbox"/>	 H 62 105 x 52 Druckbereich *: ca 80 x 40	HAB701 <input type="checkbox"/>	 H 66 96 x 56 Druckbereich *: ca 80 x 45
BT451 <input type="checkbox"/>	 H 68 98 x 53 Druckbereich *: ca 82 x 40	BT451.1 <input type="checkbox"/>	 H 53 98 x 53 Druckbereich *: ca 82 x 40	T32 <input type="checkbox"/>	 H 67 120 x 71 Druckbereich *: ca 100 x 54
T05 <input type="checkbox"/>	 H 60 129 x 67 Druckbereich *: ca 103 x 50	BT406 <input type="checkbox"/>	 H 68 130 x 55 Druckbereich *: ca 105 x 45	T88 <input type="checkbox"/>	 H 61 126 x 53 Druckbereich *: ca 110 x 30



BT249 <input type="checkbox"/>	 H 66 127 x 53 Druckbereich *: ca 110 x 42	BT263 <input type="checkbox"/>	 H 68 145 x 57 Druckbereich *: ca 115 x 40	BT316 <input type="checkbox"/>	 H 65 130 x 55 Druckbereich *: ca 120 x 44
BT317 <input type="checkbox"/>	 H 67 135 x 57 Druckbereich *: ca 125 x 40	BT398 <input type="checkbox"/>	 H 63 136 x 106 Druckbereich *: ca 125 x 100	T61/1 <input type="checkbox"/>	 H 66 160 x 75 Druckbereich *: ca 135 x 62
HAB702 <input type="checkbox"/>	 H 66 204 x 58 Druckbereich *: ca 160 x 45	BT409 <input type="checkbox"/>	 H 67 218 x 60 Druckbereich *: ca 170 x 45	BT430 <input type="checkbox"/>	 H 95 228 x 104 Druckbereich *: ca 170 x 80



BT334



H
82

224 x 118

Druckbereich *: ca 200 x 90

Druckbereich *: ca

Druckbereich *: ca

Druckbereich *: ca

Druckbereich *: ca

Druckbereich *: ca

Druckbereich *: ca

Druckbereich *: ca

Druckbereich *: ca



Drucktampons - Serie 800

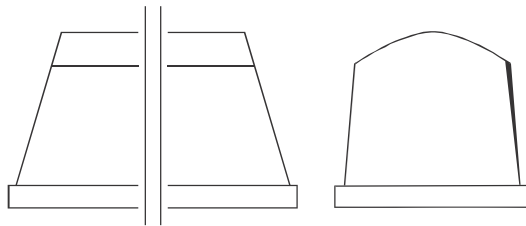

Drucktampons – Serie 800 sind in den Härten 0-30 Shore A standardmäßig auf Holz- Aluminium oder Stahlsockel mit M6 Gewinde erhältlich.

Wir fertigen auch speziell angepasste Klickhalterungen, mit denen Sie den Drucktampon ohne Werkzeug und ohne die Maschine neu einstellen zu müssen, wechseln können.

Für kleinere Druckflächen und Montagen von mehreren kleinen Tampons siehe Serie 900 MINI.

BT237



H 36

35 x 27

Druckbereich *: ca 26 x 22

BT207



H 35

39 x 35

Druckbereich *: ca 28 x 20

BT486



H 34

50 x 33

Druckbereich *: ca 35 x 24

BT22



H 27

60 x 10

Druckbereich *: ca 40 x 6
Aluminiumsockel / M6 x 2

BT45



H 38

50 x 35

Druckbereich *: ca 40 x 24

BT407



H 26

49 x 22

Druckbereich *: ca 42 x 16
Aluminiumsockel / M6







BT205  H 62 91 x 63 Druckbereich *: ca 42 x 40	BT95  H 38 60 x 34 Druckbereich *: ca 44 x 14	HAB809  H 52 62 x 54 Druckbereich *: ca 45 x 35
BT51  H 27 60 x 10 Druckbereich *: ca 46 x 6 Aluminiumsockel / M6 x 2	BT13  H 21 50 x 20 Druckbereich *: ca 46 x 12 Aluminiumsockel / M5	BT312  H 19 54 x 20 Druckbereich *: ca 48 x 12 Stålsocket / M6 - C30
BT79  H 35 56 x 34 Druckbereich *: ca 50 x 20	BT251  H 31 71 x 35 Druckbereich *: ca 52 x 22	BT62  H 26 59 x 20 Druckbereich *: ca 56 x 14



Drucktampons - Serie 800

Produktkatalog 2019-1 Seite 4-15 - 3

BT17	 <p>H 35</p>	BT246	 <p>H 41</p>	HAB413	 <p>H 18</p>
62 x 35		91 x 43		71 x 10	
Druckbereich *: ca 58 x 23		Druckbereich *: ca 62 x 22		Druckbereich *: ca 64 x 5 Aluminiumsockel / M6	
BT48	 <p>H 18</p>	T42	 <p>H 21</p>	HAB808	 <p>H 52</p>
71 x 10		72 x 22		90 x 54	
Druckbereich *: ca 64 x 7 Aluminiumsockel / M5 x 2		Druckbereich *: ca 64 x 14		Druckbereich *: ca 65 x 35	
T122	 <p>H 27</p>	BT490	 <p>H 40</p>	BT14	 <p>H 26</p>
74 x 22		80 x 21		76 x 20	
Druckbereich *: ca 66 x 16 Aluminiumsockel / M6		Druckbereich *: ca 70 x 15		Druckbereich *: ca 72 x 12	



Drucktampons - Serie 800

Produktkatalog 2019-1 Seite 4-15 - 4

T18  H 33 91 x 35 Druckbereich *: ca 74 x 25	BT437  H 24 130 x 24 Druckbereich *: ca 75 x 10 Stålsokkel / M6 - C109	BT77  H 35 85 x 35 Druckbereich *: ca 75 x 23
BT230  H 62 120 x 58 Druckbereich *: ca 78 x 45	BT88  H 21 83 x 11 Druckbereich *: ca 80 x 7 Aluminiumsockel / M6	BT180  H 36 96 x 35 Druckbereich *: ca 83 x 23
HAB802  H 52 103 x 54 Druckbereich *: ca 85 x 35	BT232  H 62 120 x 50 Druckbereich *: ca 86 x 44	BT232.1  H 60 124 x 56 Druckbereich *: ca 86 x 45



BT262  H 59 108 x 62 Druckbereich *: ca 90 x 50	BT234  H 63 140 x 81 Druckbereich *: ca 90 x 58	BT91  H 21 97 x 11 Druckbereich *: ca 92 x 7 Aluminiumsockel / M6
BT399  H 31 120 x 30 Druckbereich *: ca 95 x 20	BT18  H 35 100 x 35 Druckbereich *: ca 95 x 23	HAB810  H 52 112 x 54 Druckbereich *: ca 95 x 35
BT229  H 37 103 x 30 Druckbereich *: ca 98 x 25	BT235  H 64 145 x 64 Druckbereich *: ca 98 x 46	T63  H 60 153 x 63 Druckbereich *: ca 98 x 50



Drucktampons - Serie 800

Produktkatalog 2019-1 Seite 4-15 - 6

BT438	 H 19	T79	 H 35	BT293	 H 30
130 x 24		112 x 34		114 x 22	
Druckbereich *: ca 100 x 14 Stälsocket / M6 - C109		Druckbereich *: ca 100 x 24		Druckbereich *: ca 105 x 15	
BT244	 H 33	BT314	 H 22	BT212	 H 35
129 x 36		128 x 19		128 x 36	
Druckbereich *: ca 108 x 25		Druckbereich *: ca 110 x 14 Aluminiumsocket / M6		Druckbereich *: ca 110 x 25	
BT236	 H 58	BT311	 H 20	HAB804	 H 30
154 x 62		130 x 19		143 x 28	
Druckbereich *: ca 110 x 40		Druckbereich *: ca 120 x 12 Stälsocket / M6 - C30		Druckbereich *: ca 130 x 15	



HAB803	
	H 52
184 x 54	
Druckbereich *: ca 165 x 35	

HAB801	
	H 26
203 x 20	
Druckbereich *: ca 190 x 10	

T58	
	H 23
210 x 22	
Druckbereich *: ca 190 x 14	

BT472	
	H 36
219 x 34	
Druckbereich *: ca 205 x 20	

BT163	
	H 70
255 x 107	
Druckbereich *: ca 210 x 70	

BT240	
	H 57
244 x 62	
Druckbereich *: ca 225 x 48	

BT185	
	H 54
272 x 49	
Druckbereich *: ca 230 x 30	

BT49	
	H 24
290 x 20	
Druckbereich *: ca 270 x 13	

BT16	
	H 26
289 x 20	
Druckbereich *: ca 275 x 13	



T02  H 36 294 x 36 Druckbereich *: ca 275 x 22	HAB805  H 36 286 x 35 Druckbereich *: ca 275 x 24	BT417  H 36 298 x 28 Druckbereich *: ca 290 x 20
HAB811  H 38 344 x 35 Druckbereich *: ca 300 x 24	BT549  H 70 356 x 108 Druckbereich *: ca 300 x 80	HAB806  H 56 345 x 67 Druckbereich *: ca 320 x 52
BT296  H 68 470 x 107 Druckbereich *: ca 450 x 55	BT497  H 30 554 x 25 Druckbereich *: ca 510 x 18	BT484  H 35 550 x 33 Druckbereich *: ca 535 x 20



Drucktampons - Serie 850

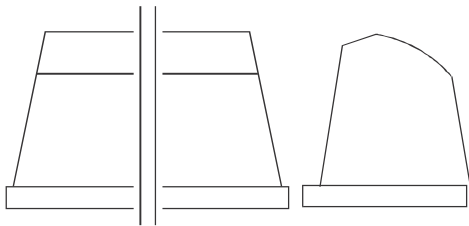

Drucktampons – Serie 850 sind in den Härten 0-30 Shore A standardmäßig auf Holz- Aluminium oder Stahlsockel mit M6 Gewinde erhältlich.

Wir fertigen auch speziell angepasste Klickhalterungen, mit denen Sie den Drucktampon ohne Werkzeug und ohne die Maschine neu einstellen zu müssen, wechseln können.

Für kleinere Druckflächen und Montagen von mehreren kleinen Tampons siehe Serie 900 MINI.

BT280



H
40

57 x 40

Druckbereich *: ca 24 x 18

BT239



H
33

35 x 28

Druckbereich *: ca 25 x 15

BT268



H
48

51 x 30

.. Druckbereich *: ca 30 x 18

BT44



H
38

42 x 35

Druckbereich *: ca 32 x 15

BT275



H
53

57 x 40

Druckbereich *: ca 39 x 27

T119



H
20

50 x 17

Druckbereich *: ca 43 x 11
Aluminiumsockel / M6



BT350  60 x 14 Druckbereich *: ca 55 x 9 Aluminiumsockel / M6 H 20	T56  64 x 12 Druckbereich *: ca 57 x 9 Aluminiumsockel / M5 H 15	BT524  70 x 19 Druckbereich *: ca 58 x 13 Aluminiumsockel / M6 H 25
BT554  74 x 17 Druckbereich *: ca 68 x 12 Aluminiumsockel / M6 H 25	BT47  74 x 18 Druckbereich *: ca 68 x 13 H 26	BT247  75 x 18 Druckbereich *: ca 70 x 13 H 24
BT73  79 x 12 Druckbereich *: ca 72 x 8 Aluminiumsockel / M6 H 15	BT298  94 x 54 Druckbereich *: ca 75 x 28 H 52	BT299  104 x 12 Druckbereich *: ca 80 x 9 Aluminiumsockel / M6 H 16



T107		H 23
95 x 15		
Druckbereich *: ca 82 x 9		

BT358		H 58
109 x 48		
Druckbereich *: ca 95 x 30		

BT309		H 17
112 x 12		
Druckbereich *: ca 105 x 8 Aluminiumsockel / M6		

T17		H 24
210 x 18		
Druckbereich *: ca 198 x 13		

BT551		H 65
305 x 92		
Druckbereich *: ca 260 x 50 Stålsockel / M6 - C126		

BT531		H 65
320 x 30		
Druckbereich *: ca 300 x 18		

BT550		H 65
355 x 92		
Druckbereich *: ca 300 x 50 Stålsockel / M6 - C126		

BT408		H 65
360 x 75		
Druckbereich *: ca 320 x 35		

Druckbereich *: ca		



Drucktampons - Serie 900 MINI **M**

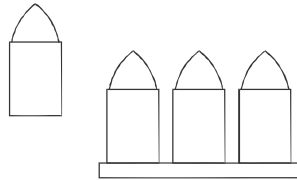

Drucktampons – Serie 900 mini sind in den Härten 0-30 Shore A standardmäßig auf Holz- Aluminium oder Stahlsockel mit M6 Gewinde erhältlich.

Wir fertigen auch speziell angepasste Klickhalterungen, mit denen Sie den Drucktampon ohne Werkzeug und ohne die Maschine neu einstellen zu müssen, wechseln können.

Für kleinere Druckflächen und Montagen von mehreren kleinen Tampons siehe Serie 900 MINI.

BT37 **M**



H
13

Ø 9

Druckbereich *: ca Ø 5
Aluminiumsockel / M4

T129 **M**



H
19

Ø 9

Druckbereich *: ca Ø 6
Aluminiumsockel / M4

T124 **M**



H
19

Ø 11

Druckbereich *: ca Ø 7
Aluminiumsockel / M4

BT11 **M**



H
34

Ø 12

Druckbereich *: ca Ø 8
Aluminiumsockel / M6

BT507 **M**



H
33

Ø 12

Druckbereich *: ca Ø 8 (special)
Aluminiumsockel / M6

BT508 **M**



H
33

Ø 12

Druckbereich *: ca Ø 8
Aluminiumsockel / M6



BT518 M  Ø 12 Druckbereich *: ca Ø 8 Aluminiumsockel / M6 H 33	BT352 M  Ø 15 Druckbereich *: ca Ø 10 Aluminiumsockel / M5 H 16	BT369 M  Ø 12 Druckbereich *: ca Ø 10 Aluminiumsockel / M6 H 32
BT100 M  Ø 15 Druckbereich *: ca Ø 12 Aluminiumsockel / M4 H 13	BT364 M  Ø 15 Druckbereich *: ca Ø 12 Aluminiumsockel / M4 H 16	BT415 M  Ø 16 Druckbereich *: ca Ø 12 Aluminiumsockel / M4 H 24
BT272 M  Ø 20 Druckbereich *: ca Ø 14 Aluminiumsockel / M5 H 27	BT198 M  Ø 20 Druckbereich *: ca Ø 15 Aluminiumsockel / M5 H 24	BT346 M  Ø 19 Druckbereich *: ca Ø 15 Aluminiumsockel / M5 H 24



BT347 M  H 28 17 x 17 Druckbereich *: ca Ø 15 Aluminiumsockel / M5	BT65 M  H 24 Ø 18 Druckbereich *: ca Ø 15 Aluminiumsockel / M5	BT69 M  H 23 Ø 20 Druckbereich *: ca Ø 15 Aluminiumsockel / M5
BT80 M  H 22 Ø 27 Druckbereich *: ca Ø 15 Aluminiumsockel / M6	BT101 M  H 24 Ø 17 Druckbereich *: ca Ø 16 Aluminiumsockel / M5	T30 M  H 20 Ø 22 Druckbereich *: ca Ø 17 Aluminiumsockel / M6
BT102 M  H 22 Ø 20 Druckbereich *: ca Ø 18 Aluminiumsockel / M5	BT104 M  H 25 Ø 20 Druckbereich *: ca Ø 18 Aluminiumsockel M5	BT353 M  H 25 Ø 20 Druckbereich *: ca Ø 18 Aluminiumsockel / M5



BT356 M  Ø 20 Druckbereich *: ca Ø 18 Aluminiumsockel / M5 H 29	BT357 M  Ø 20 Druckbereich *: ca Ø 18 Aluminiumsockel / M5 H 25	BT60 M  Ø 20 Druckbereich *: ca Ø 18 Aluminiumsockel / M5 H 25
BT156 M  Ø 20 Druckbereich *: ca Ø 20 Aluminiumsockel / M5 H 25	BT458 M  Ø 25 Druckbereich *: ca Ø 20 Aluminiumsockel / M6 H 25	M Druckbereich *: ca
M Druckbereich *: ca	M Druckbereich *: ca	M Druckbereich *: ca



BT64 M  H 22 14 x 10 Druckbereich *: ca 11 x 8 Aluminiumsockel / M5	T103 M  H 23 Ø 20 Druckbereich *: ca 12 x 9 Aluminiumsockel / M5	T67 M  H 21 14 x 10 Druckbereich *: ca 12 x 9 Aluminiumsockel / M4
T85 M  H 22 20 x 20 Druckbereich *: ca 12 x 12 Aluminiumsockel / M6	BT96 M  H 20 16 x 10 Druckbereich *: ca 13 x 9 Aluminiumsockel / M5	BT97 M  H 24 18 x 18 Druckbereich *: ca 13 x 13 Aluminiumsockel / M6
BT292 M  H 19 16 x 12 Druckbereich *: ca 14 x 9 Aluminiumsockel / M6	BT94 M  H 25 16 x 10 Druckbereich *: ca 14 x 9 Aluminiumsockel / M5	BT345 M  H 28 16 x 13 Druckbereich *: ca 15 x 12 Aluminiumsockel / M5



Drucktampons - Serie 900 MINI





Produktkatalog 2019-1 Seite 4-17 - 6

BT1 M  H 29 17 x 17 Druckbereich *: ca 15 x 15 Aluminiumsockel / M5	BT46 M  H 20 18 x 18 Druckbereich *: ca 15 x 15 Aluminiumsockel / M6	BT40 M  H 24 Ø 25 Druckbereich *: ca 16 x 6 Stalsockel / M6 - C16
BT513 M  H 24 20 x 16 Druckbereich *: ca 16 x 10 Aluminiumsockel / M5	T59 M  H 15 21 x 15 Druckbereich *: ca 17 x 9 Aluminiumsockel / M5	BT50 M  H 30 Ø 25 Druckbereich *: ca 18 x 6 Aluminiumsockel / M6
HAB418 M  H 24 24 x 10 Druckbereich *: ca 18 x 9 Aluminiumsockel / M5	BT200 M  H 24 13 x 6 Druckbereich *: ca 18 x 13 Aluminiumsockel / M5	T10 M  H 24 25 x 21 Druckbereich *: ca 18 x 14 Aluminiumsockel / M6











Drucktampons - Serie 900 MINI

Produktkatalog 2019-1 Seite 4-17 - 7

BT50.1 M	HAB416 M	BT341 M
		
<p style="text-align: right;">H 39</p>	<p style="text-align: right;">H 25</p>	<p style="text-align: right;">H 29</p>
<p style="text-align: center;">Ø 25</p>	<p style="text-align: center;">30 x 18</p>	<p style="text-align: center;">24 x 17</p>
<p>Druckbereich *: ca 20 x 5 Aluminiumsockel / M6</p>	<p>Druckbereich *: ca 22 x 10 Aluminiumsockel / M6</p>	<p>Druckbereich *: ca 22 x 15 Aluminiumsockel / M5</p>
BT206 M	M	M
		
<p style="text-align: right;">H 26</p>		
<p style="text-align: center;">31 x 17</p>		
<p>Druckbereich *: ca 29 x 15 Aluminiumsockel / M5</p>	<p>Druckbereich *: ca</p>	<p>Druckbereich *: ca</p>
M	M	M
<p>Druckbereich *: ca</p>	<p>Druckbereich *: ca</p>	<p>Druckbereich *: ca</p>





BT2 M  H 28 18 x 18 Druckbereich *: ca 12 x 12 Aluminiumsockel / M5	BT359 M  H 28 18 x 18 Druckbereich *: ca 12 x 12 Aluminiumsockel / M5	BT9 M  H 28 17 x 14 Druckbereich *: ca 14 x 12
BT228 M  H 25 21 x 18 Druckbereich *: ca 19 x 15 Aluminiumsockel / M5	BT155 M  H 34 21 x 8 Druckbereich *: ca 20 x 7 Aluminiumsockel / M2 x 2	BT3 M  H 29 25 x 17 Druckbereich *: ca 20 x 14 Aluminiumsockel / M5
BT343 M  H 29 26 x 17 Druckbereich *: 20 x 14 Aluminiumsockel / M5	BT98 M  H 25 28 x 18 Druckbereich *: ca 24 x 10 Aluminiumsockel / M5	BT342 M  H 28 28 x 17 Druckbereich *: 24 x 14 Aluminiumsockel / M5



Drucktampons - Serie 900 MINI



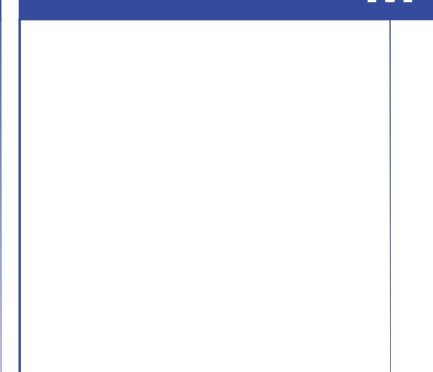
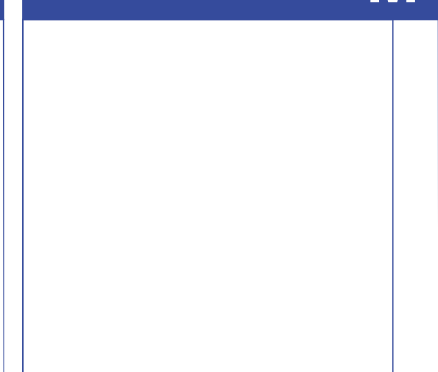





Produktkatalog 2019-1 Seite 4-17 - 9

BT344 M	BT540 M	BT154 M
		
<p style="text-align: right;">H 29</p>	<p style="text-align: right;">H 25</p>	<p style="text-align: right;">H 29</p>
<p style="text-align: center;">29 x 17</p>	<p style="text-align: center;">28 x 15</p>	<p style="text-align: center;">32 x 20</p>
<p>Druckbereich *: ca 24 x 14 Aluminiumsockel / M5</p>	<p>* Druckbereich : ca 25 x 12 Aluminiumsockel / M5</p>	<p>Druckbereich *: ca 26 x 15 Aluminiumsockel / M5 / M4 x 2</p>
BT99 M	BT340 M	BT4 M
		
<p style="text-align: right;">H 25</p>	<p style="text-align: right;">H 24</p>	<p style="text-align: right;">H 29</p>
<p style="text-align: center;">38 x 18</p>	<p style="text-align: center;">38 x 17</p>	<p style="text-align: center;">38 x 17</p>
<p>Druckbereich *: ca 34 x 12 Aluminiumsockel / M5</p>	<p>Druckbereich *: ca 35 x 14 Aluminiumsockel / M5</p>	<p>Druckbereich *: ca 35 x 14 Aluminiumsockel / M6</p>
M	M	M
		
<p>Druckbereich *: ca</p>	<p>Druckbereich *: ca</p>	<p>Druckbereich *: ca</p>







Drucktampons - Serie 900 MINI

Produktkatalog 2019-1 Seite 4-17 - 10

BT25 M  H 23 24 x 10 Druckbereich *: ca 10 x 6 Aluminiumsockel / M6	BT12 M  H 23 13 x 23 Druckbereich *: ca 10 x 12 Aluminiumsockel / M5	BT303 M  H 20 16 x 10 Druckbereich *: ca 14 x 10 Aluminiumsockel / M5
BT39 M  H 22 17 x 21 Druckbereich *: ca 15 x 10 Aluminiumsockel / M6	BT86 M  H 20 20 x 10 Druckbereich *: ca 16 x 6 Aluminiumsockel / M5	BT24 M  H 27 29 x 10 Druckbereich *: ca 16 x 6 Aluminiumsockel / M5
BT87 M  H 21 18 x 13 Druckbereich *: ca 16 x 9 Aluminiumsockel / M5	T75/1 M  H 15 25 x 8 Druckbereich *: ca 20 x 7 Aluminiumsockel / M5	BT23 M  H 25 29 x 10 Druckbereich *: ca 22 x 6 Aluminiumsockel / M6



<p>T75/3 M</p>	<p>BT304 M</p>	<p>BT204 M</p>
 <p>H 15</p>	 <p>H 20</p>	 <p>H 23</p>
<p>45 x 8</p>	<p>31 x 10</p>	<p>35 x 17</p>
<p>Druckbereich *: ca 28 x 7 Aluminiumsockel / M5</p>	<p>Druckbereich *: ca 31 x 10 Aluminiumsockel / M5</p>	<p>Druckbereich *: ca 33 x 11 Aluminiumsockel / M6</p>
<p>BT301 M</p>	<p>T75 M</p>	<p>M</p>
 <p>H 24</p>	 <p>H 15</p>	
<p>40 x 13</p>	<p>45 x 8</p>	
<p>Druckbereich *: ca 34 x 10 Aluminiumsockel / M5</p>	<p>Druckbereich *: ca 40 x 7 Aluminiumsockel / M5</p>	<p>Druckbereich *: ca</p>
<p>M</p>	<p>M</p>	<p>M</p>
<p>Druckbereich *: ca</p>	<p>Druckbereich *: ca</p>	<p>Druckbereich *: ca</p>



Drucktampons - Serie 900 MINI





Produktkatalog 2019-1 Seite 4-17 - 12

BT302 M  H 20 22 x 15 Druckbereich *: ca 20 x 5 Aluminiumsockel / M5	T56/2 M  H 15 24 x 12 Druckbereich *: ca 21 x 9 Aluminiumsockel / M5	T12 M  H 22 27 x 5 Druckbereich *: ca 33 x 20 Aluminiumsockel / M6
BT201 M  H 25 36 x 13 Druckbereich *: ca 34 x 10 Aluminiumsockel / M6	T56/1 M  H 15 40 x 12 Druckbereich *: 37 x 9 Aluminiumsockel / M5	BT202 M  H 21 47 x 13 Druckbereich *: ca 45 x 10 Aluminiumsockel / M6
M Druckbereich *: ca	M Druckbereich *: ca	M Druckbereich *: ca



Drucktampons - Serie 900 MINI

Produktkatalog 2019-1 Seite 4-17 - 13

BT5 M  H 28 28 x 22 Druckbereich *: nicht angegeben Aluminiumsocket / M5	BT6 M  H 28 28 x 22 Druckbereich *: nicht angegeben Aluminiumsocket / M5	BT7 M  H 28 28 x 22 Druckbereich *: nicht angegeben Aluminiumsocket / M5
BT8 M  H 28 35 x 25 Druckbereich *: nicht angegeben Aluminiumsocket / M5	M Druckbereich *: ca	M Druckbereich *: ca
M Druckbereich *: ca	M Druckbereich *: ca	M Druckbereich *: ca



Drucktampons - Serie 950 SPECIAL **S**

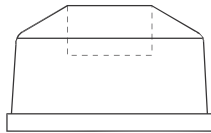

Drucktampons – Serie 950 spezial mini sind in den Härten 0-30 Shore A standartmäßig auf Holz- Aluminium oder Stahlsockel mit M6 Gewinde erhältlich.

Wir fertigen auch speziell angepasste Klickhalterungen, mit denen Sie den Drucktampon ohne Werkzeug und ohne die Maschine neu einstellen zu müssen, wechseln können.

Für kleinere Druckflächen und Montagen von mehreren kleinen Tampons siehe Serie 900 MINI.

BT136	S
	H 40
Ø 46	
Druckbereich *: ca 30 x 24 - Ø 11 x 10	

BT158	S
	H 41
Ø 47	
Druckbereich *: nicht angegeben	

BT330	S
	H 45
55 x 40	
Druckbereich *: nicht angegeben	

BT422	S
	H 61
74 x 74	
Druckbereich *: ca 60 x 60 - Ø 26/20 x 16	

BT165A	S
	H 65
78 x 78	
Druckbereich *: nicht angegeben	

BT533	S
	H 42
80 x 50	
Druckbereich *: nicht angegeben Stalsockel / M6 - C36	



BT543 S  80 x 50 Druckbereich *: nicht angegeben Stalsocket / M6 - C36 H 38	BT482 S  93 x 54 Druckbereich *: nicht angegeben H 52	BT283 S  94 x 89 Druckbereich *: ca 75 x 65 - Loch Ø 37 x 45 H 76
S  Druckbereich *: ca	S  Druckbereich *: ca	S  Druckbereich *: ca
S  Druckbereich *: ca	S  Druckbereich *: ca	S  Druckbereich *: ca



Drucktampons - Serie 950 SPECIAL

Produktkatalog 2019-1 Seite 4-18 - 3

BT307 S	BT85 S	T118 S
		
<p style="text-align: right;">H 37</p>	<p style="text-align: right;">H 38</p>	<p style="text-align: right;">H 45</p>
<p style="text-align: center;">Ø 39</p> <p>Druckbereich *: nicht angegeben Stalsocket / M6 - C30</p>	<p style="text-align: center;">Ø 40</p> <p>Druckbereich *: ca Ø 30 - Loch Ø 19 x 5</p>	<p style="text-align: center;">Ø 45</p> <p>Druckbereich *: ca Ø 35 - Loch Ø 17 x 14</p>
BT113 S	BT361 S	BT504 S
		
<p style="text-align: right;">H 40</p>	<p style="text-align: right;">H 39</p>	<p style="text-align: right;">H 38</p>
<p style="text-align: center;">Ø 46</p> <p>Druckbereich *: ca Ø 38 - hal Ø 7 x 5</p>	<p style="text-align: center;">Ø 46</p> <p>Druckbereich *: ca Ø 50 - Loch 18/34 x 29</p>	<p style="text-align: center;">Ø 46</p> <p>Druckbereich *: nicht angegeben Aluminiumsocket / M6</p>
BT509 S	T108 S	T120 S
		
<p style="text-align: right;">H 38</p>	<p style="text-align: right;">H 42</p>	<p style="text-align: right;">H 60</p>
<p style="text-align: center;">Ø 46</p> <p>Druckbereich *: nicht angegeben Aluminiumsocket / M6</p>	<p style="text-align: center;">Ø 45</p> <p>Druckbereich *: ca Ø 35 - Loch Ø 25 x 11</p>	<p style="text-align: center;">Ø 60</p> <p>Druckbereich *: ca Ø 54 - Loch Ø 32 x 21</p>



BT424 S  H 55 Ø 61 Druckbereich *: nicht angegeben Aluminiumsockel / M6	BT321 S  H 48 Ø 62 Druckbereich *: ca Ø 40 - Loch Ø 11 x 3	BT274 S  H 54 Ø 63 Druckbereich *: nicht angegeben
BT502 S  H 48 Ø 63 Druckbereich *: ca Ø 40 - Loch Ø 11 x 14	BT148 S  H 58 Ø 64 Druckbereich *: nicht angegeben	BT149 S  H 56 Ø 65 Druckbereich *: ca Ø 52 - Loch Ø 20 x 8
BT329 S  H 55 Ø 65 Druckbereich *: ca Ø 52 - hal Ø 30 x 9	BT38 S  H 56 Ø 65 Druckbereich *: ca Ø 50 - Loch Ø 24 x 8	BT134 S  H 50 Ø 68 Druckbereich *: ca Ø 50 - Loch Ø 26 x 8



BT183 S  H 55 Ø 68 Druckbereich *: nicht angegeben	BT410 S  H 55 Ø 70 Druckbereich *: ca Ø 65 - Loch Ø 34 x 30	BT402-18 S  H 56 Ø 72 Druckbereich *: nicht angegeben
BT159 S  H 50 Ø 76 Druckbereich *: nicht angegeben	BT53 S  H 47 Ø 76 Druckbereich *: ca Ø 60 - Loch Ø 25 x 20	BT63 S  H 47 Ø 76 Druckbereich *: ca Ø 60 - Loch Ø 28 x 20
BT184 S  H 62 Ø 78 Druckbereich *: ca Ø 50 - Loch Ø 20 x 26	BT354 S  H 62 Ø 78 Druckbereich *: ca Ø 58 - Loch Ø 29 x 26	BT78 S  H 68 Ø 78 Druckbereich *: ca Ø 60 - Loch Ø 28 x 20



Drucktampons - Serie 950 SPECIAL

Produktkatalog 2019-1 Seite 4-18 - 6

T117 S	T117.1 S	BT132 S
		
<p>Ø 88</p>	<p>Ø 90</p>	<p>Ø 91</p>
<p>H 64</p> <p>Druckbereich *: ca Ø 70 - Loch Ø 30 x 21</p>	<p>H 64</p> <p>Druckbereich *: ca Ø 70 - Loch Ø 30 x 11</p>	<p>H 63</p> <p>Druckbereich *: ca Ø 75 - Loch Ø 38 x 20/32</p>
BT411 S	BT179 S	BT179.1 S
		
<p>Ø 123</p>	<p>124 x 114</p>	<p>124 x 114</p>
<p>H 58</p> <p>Druckbereich *: nicht angegeben</p>	<p>H 82</p> <p>Druckbereich *: ca 100 x 85 - Loch Ø 28 x 32</p>	<p>H 79</p> <p>Druckbereich *: ca 100 x 85 - Loch Ø 48 x 36</p>
BT181 S	S	S
		
<p>124 x 114</p>		
<p>H 78</p> <p>Druckbereich *: ca 100 x 85 - hal Ø 54 x 27</p>	<p>Druckbereich *: ca</p>	<p>Druckbereich *: ca</p>



HAB8002 S	BT412 S	BT431 S
		
<p>58 x 15</p>	<p>60 x 28</p>	<p>68 x 29</p>
<p>Druckbereich *: nicht angegeben Aluminiumsockel / M6</p>	<p>Druckbereich *: nicht angegeben Stalsockel / M6 - C36</p>	<p>Druckbereich *: nicht angegeben Stalsockel / M6 - C36</p>
BT392 S	BT539 S	BT28 S
		
<p>80 x 70</p>	<p>81 x 52</p>	<p>87 x 34</p>
<p>Druckbereich *: nicht angegeben Stalsockel / M6 - C36</p>	<p>Druckbereich *: nicht angegeben</p>	<p>Druckbereich *: nicht angegeben</p>
BT31 S	BT547 S	BT552 S
		
<p>87 x 34</p>	<p>87 x 84</p>	<p>87 x 84</p>
<p>Druckbereich *: nicht angegeben</p>	<p>Druckbereich *: nicht angegeben Stalsockel / M6 - C36</p>	<p>Druckbereich *: nicht angegeben Stalsockel / M6 - C36</p>



BT33 S	BT457 S	BT368 S
		
<p style="text-align: right;">H 35</p>	<p style="text-align: right;">H 28</p>	<p style="text-align: right;">H 28</p>
<p style="text-align: center;">88 x 34</p>	<p style="text-align: center;">91 x 52</p>	<p style="text-align: center;">98 x 42</p>
<p>Druckbereich *: nicht angegeben</p>	<p>Druckbereich *: nicht angegeben</p>	<p>Druckbereich *: nicht angegeben</p>
BT375 S	BT377 S	BT393 S
		
<p style="text-align: right;">H 29</p>	<p style="text-align: right;">H 24</p>	<p style="text-align: right;">H 24</p>
<p style="text-align: center;">98 x 43</p>	<p style="text-align: center;">100 x 30</p>	<p style="text-align: center;">100 x 39</p>
<p>Druckbereich *: nicht angegeben</p>	<p>Druckbereich *: nicht angegeben Stalsocket - C30</p>	<p>Druckbereich *: nicht angegeben Aluminiumsocket - C30</p>
BT365 S	BT370 S	BT391 S
		
<p style="text-align: right;">H 24</p>	<p style="text-align: right;">H 24</p>	<p style="text-align: right;">H 28</p>
<p style="text-align: center;">100 x 40</p>	<p style="text-align: center;">100 x 40</p>	<p style="text-align: center;">100 x 41</p>
<p>Druckbereich *: nicht angegeben Stalsocket - C30</p>	<p>Druckbereich *: nicht angegeben Stalsocket - C30</p>	<p>Druckbereich *: nicht angegeben Stalsocket - C30</p>



BT384 S  H 46 100 x 50 Druckbereich *: nicht angegeben Stalsocket - C36	BT394 S  H 28 105 x 70 Druckbereich *: nicht angegeben Stalsocket / M6 - C36	BT506 S  H 26 107 x 73 Druckbereich *: nicht angegeben Stalsocket / M6 - C36
BT532 S  H 26 107 x 74 Druckbereich *: nicht angegeben Stalsocket / M6 - C36	BT537 S  H 35 107 x 74 Druckbereich *: nicht angegeben Stalsocket / M6 - C36	BT92 S  H 44 117 x 70 Druckbereich *: nicht angegeben
BT139 S  H 55 127 x 77 Druckbereich *: nicht angegeben	BT135 S  H 64 127 x 78 Druckbereich *: nicht angegeben	BT404 S  H 24 130 x 24 Druckbereich *: nicht angegeben Stalsocket / M6 - C109



BT405 S  H 24 130 x 24 Druckbereich *: nicht angegeben Stalsocket / M6 - C109	BT575 S  H 29 130 x 24 Druckbereich *: nicht angegeben Stalsocket / M6 - C109	BT576 S  H 29 130 x 24 Druckbereich *: nicht angegeben Stalsocket / M6 - C109
BT510 S  H 30 145 x 48 Druckbereich *: nicht angegeben Aluminiumsocket / M6 - C127	BT138 S  H 68 150 x 100 Druckbereich *: nicht angegeben	BT546 S  H 25 153 x 105 Druckbereich *: nicht angegeben Aluminiumsocket / M6 - C36
BT538 S  H 20 154 x 115 Druckbereich *: nicht angegeben Aluminiumsocket / M6 - C36	BT527 S  H 33 330 x 25 Druckbereich *: nicht angegeben	S Druckbereich *: ca



BT127 S  H 40 60 x 55 Druckbereich *: nicht angegeben	BT130 S  H 48 Ø 60 Druckbereich *: nicht angegeben	BT15 S  H 22 50 x 20 Druckbereich *: nicht angegeben Aluminiumsockel / M6
BT157 S  H 35 55 x 36 Druckbereich *: ca 40 x 22	BT161 S  H 60 65 x 58 Druckbereich *:ca Ø 50 Stalsockel special med inv. hal	BT171 S  H 60 Ø 62 Druckbereich *: nicht angegeben
BT175 S  H 60 65 x 57 Druckbereich *: nicht angegeben Stalsockel / M6 - C30	BT19 S  H 35 100 x 36 Druckbereich *: nicht angegeben	BT20 S  H 22 103 x 20 Druckbereich *: nicht angegeben Aluminiumsockel / M6



BT224 S  H 48 68 x 52 Druckbereich *: nicht angegeben	BT230.1 S  H 60 120 x 58 Druckbereich *: nicht angegeben	BT245 S  H 30 93 x 48 Druckbereich *: nicht angegeben
BT273 S  H 80 172 x 64 Druckbereich *: nicht angegeben	BT323 S  H 25 48 x 20 Druckbereich *: nicht angegeben Stalsocket / M6 - C16	BT335 S  H 34 52 x 35 Druckbereich *: nicht angegeben Aluminiumsocket / M6
BT363 S  H 70 75 x 50 Druckbereich *: nicht angegeben	BT381 S  H 33 45 x 34 Druckbereich *: nicht angegeben Aluminiumsocket / M6	BT396 S  H 47 Ø 60 Druckbereich *: nicht angegeben Stalsocket / M6 - C36



BT455 S  71 x 47 Druckbereich *: nicht angegeben H 27	BT520 S  Ø 170 Druckbereich *: nicht angegeben Stalsocket special med inv. hal H 145	BT72 S  Ø 85 Druckbereich *: ca Ø 30 H 78
T60/2 S  70 x 55 Druckbereich *: nicht angegeben Aluminiumsocket / M6 H 44	T80/1 S  63 x 37 Druckbereich *: nicht angegeben Aluminiumsocket / M6 H 50	T87 S  66 x 41 Druckbereich *: nicht angegeben H 50
S Druckbereich *: ca	S Druckbereich *: ca	S Druckbereich *: ca